

From the library of: Diamond Needle Corp

SINGER
15K110,K112

ILLUSTRATED LIST OF PARTS

FOR

Nos. 15K110 to 15K112 MACHINES



**A Trademark of THE SINGER MANUFACTURING COMPANY

121170

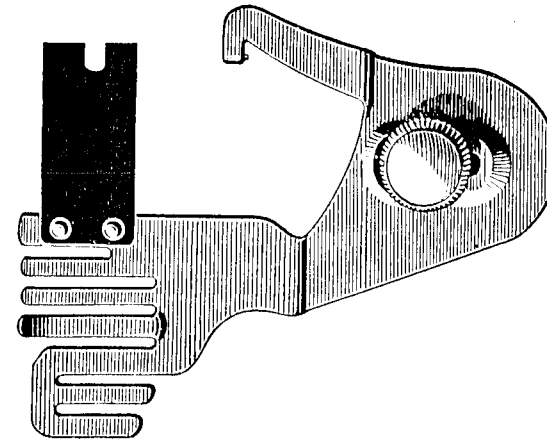

121547

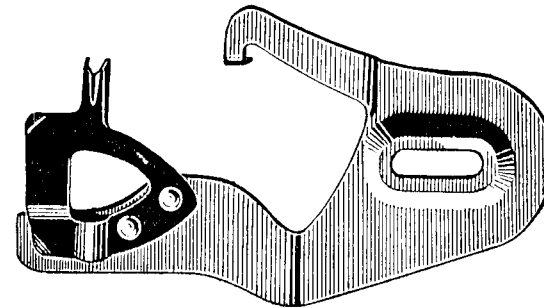

From the library of: Diamond Needle Corp

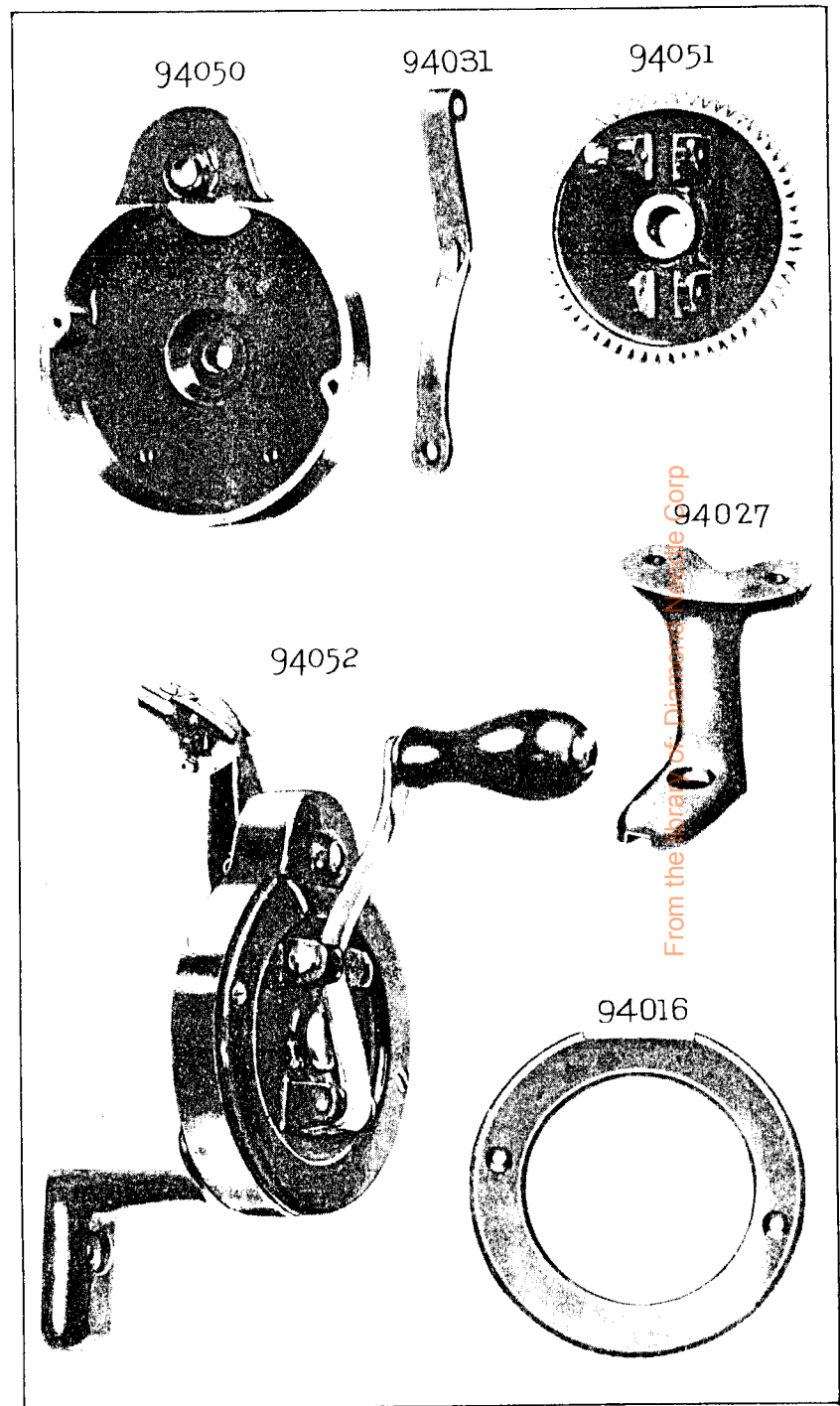
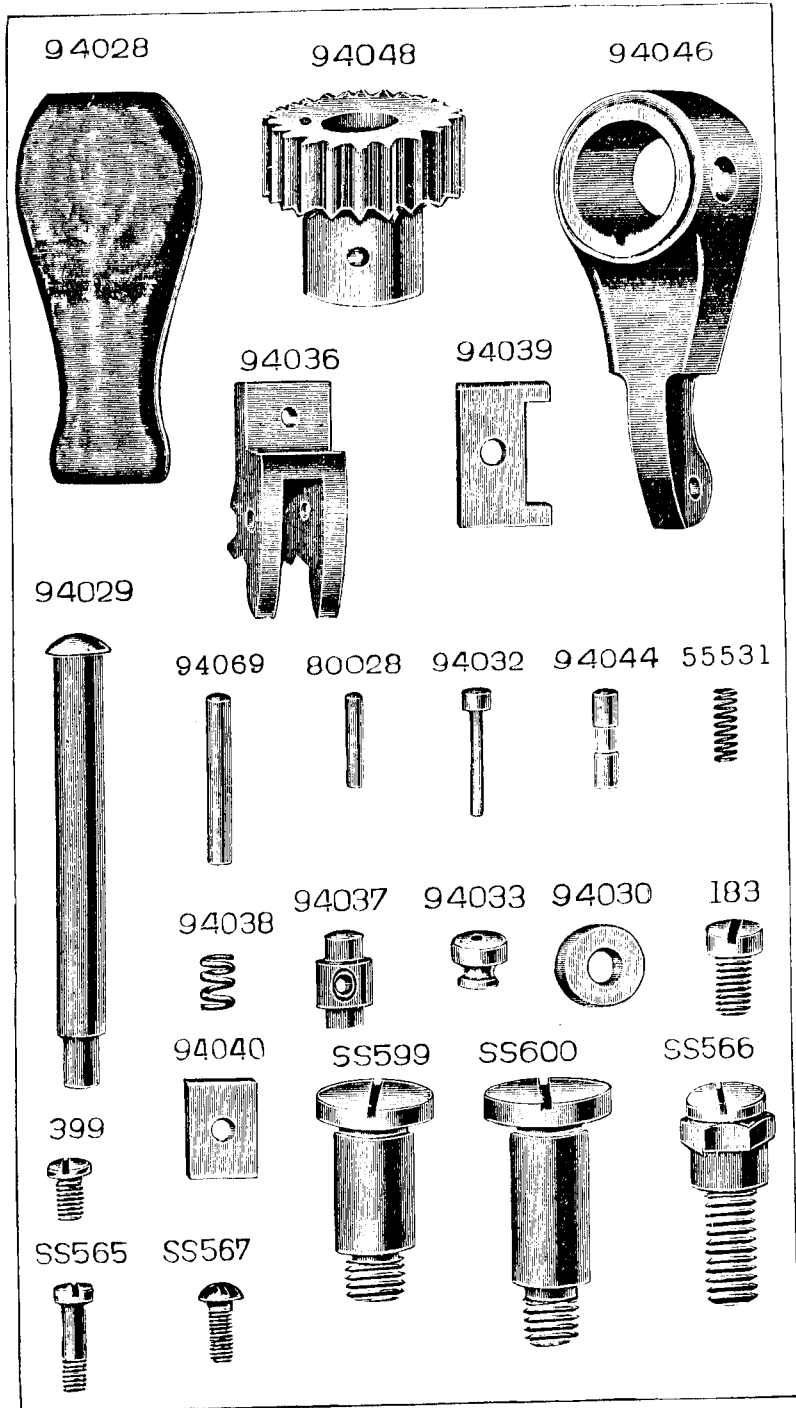

SS 528



96425



96426



96844



96427



96845



NW95



86742

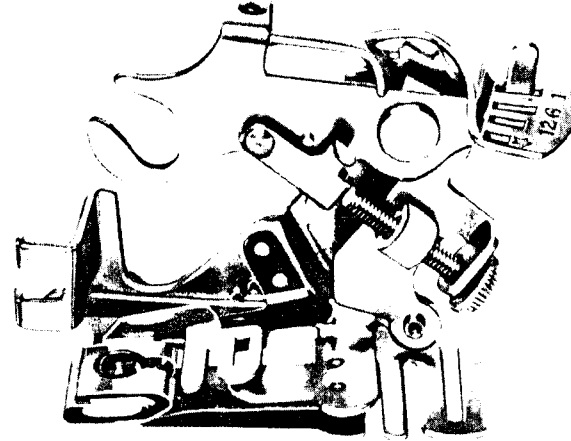

121441



36865

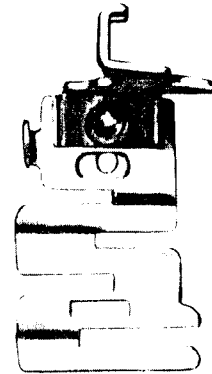

121464

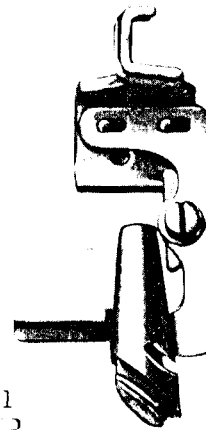

161295



161294

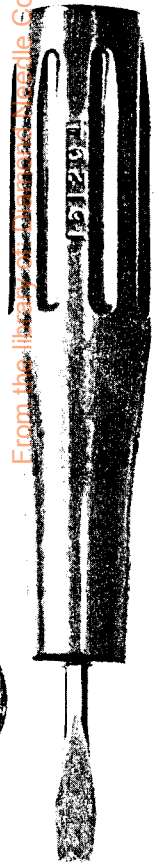

35931

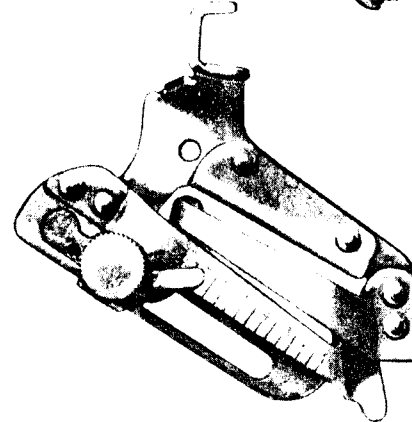

8879

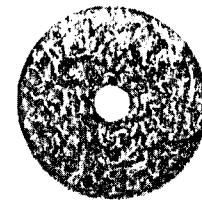

From the illustrations prepared by the Ordnance Corps

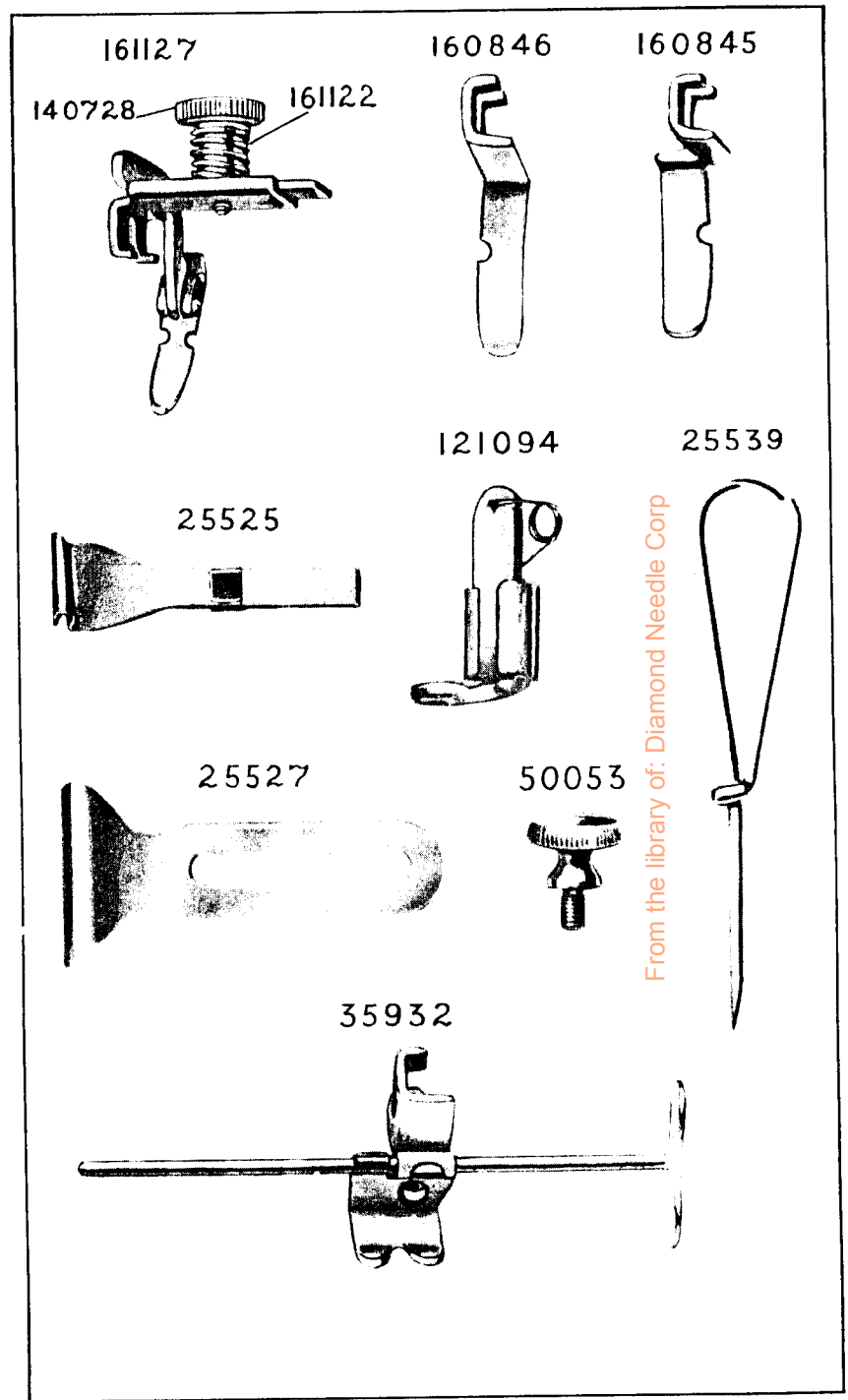
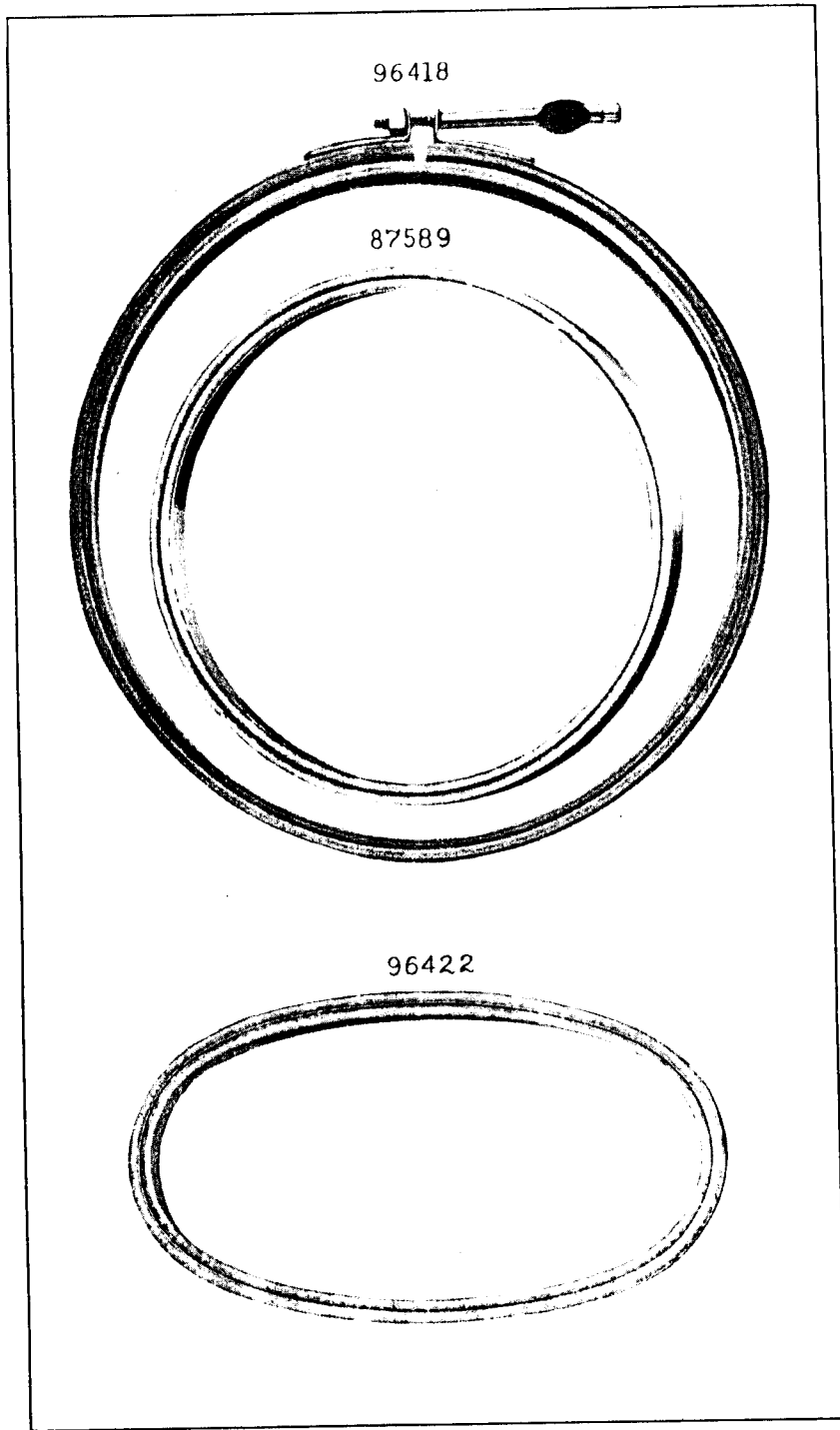

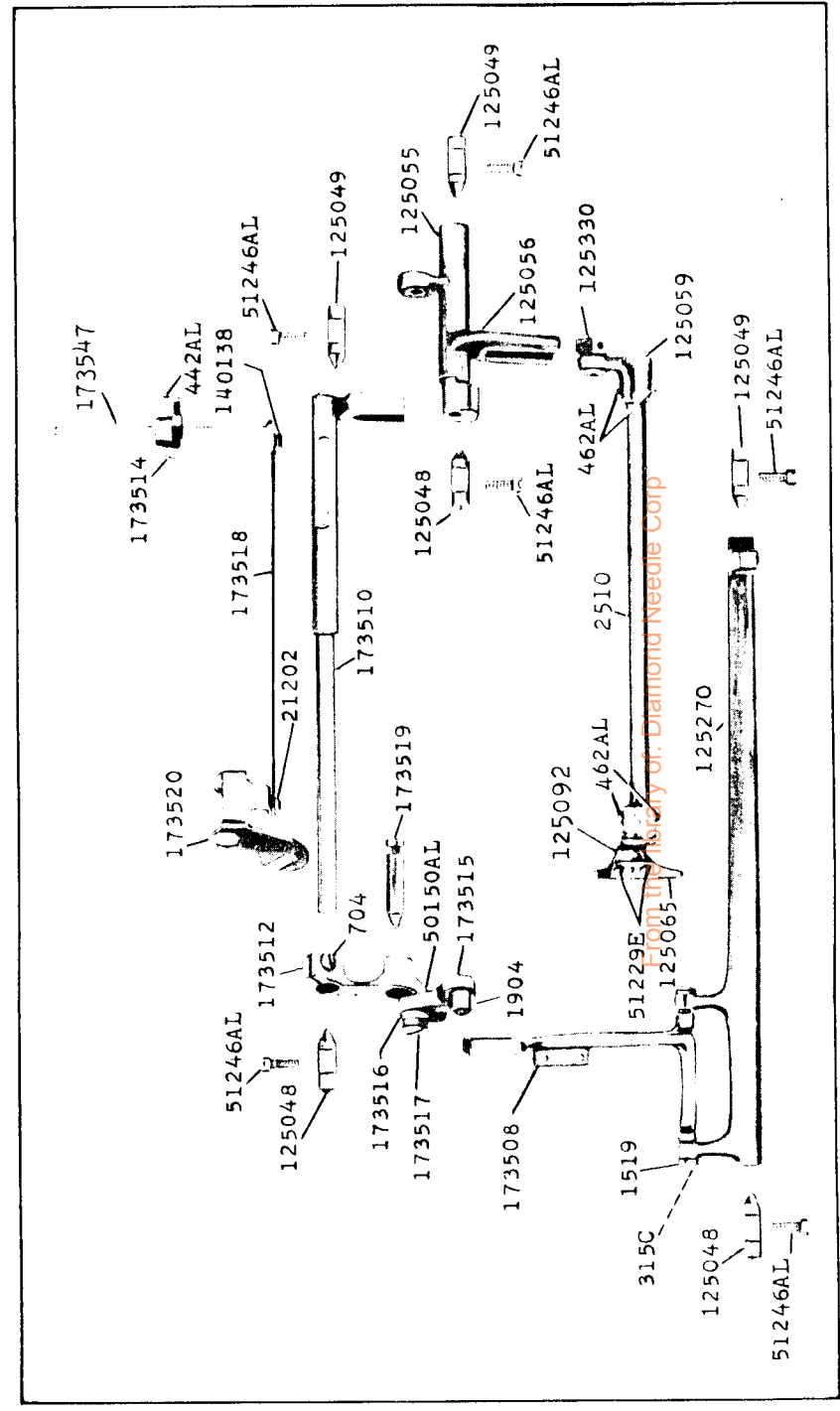
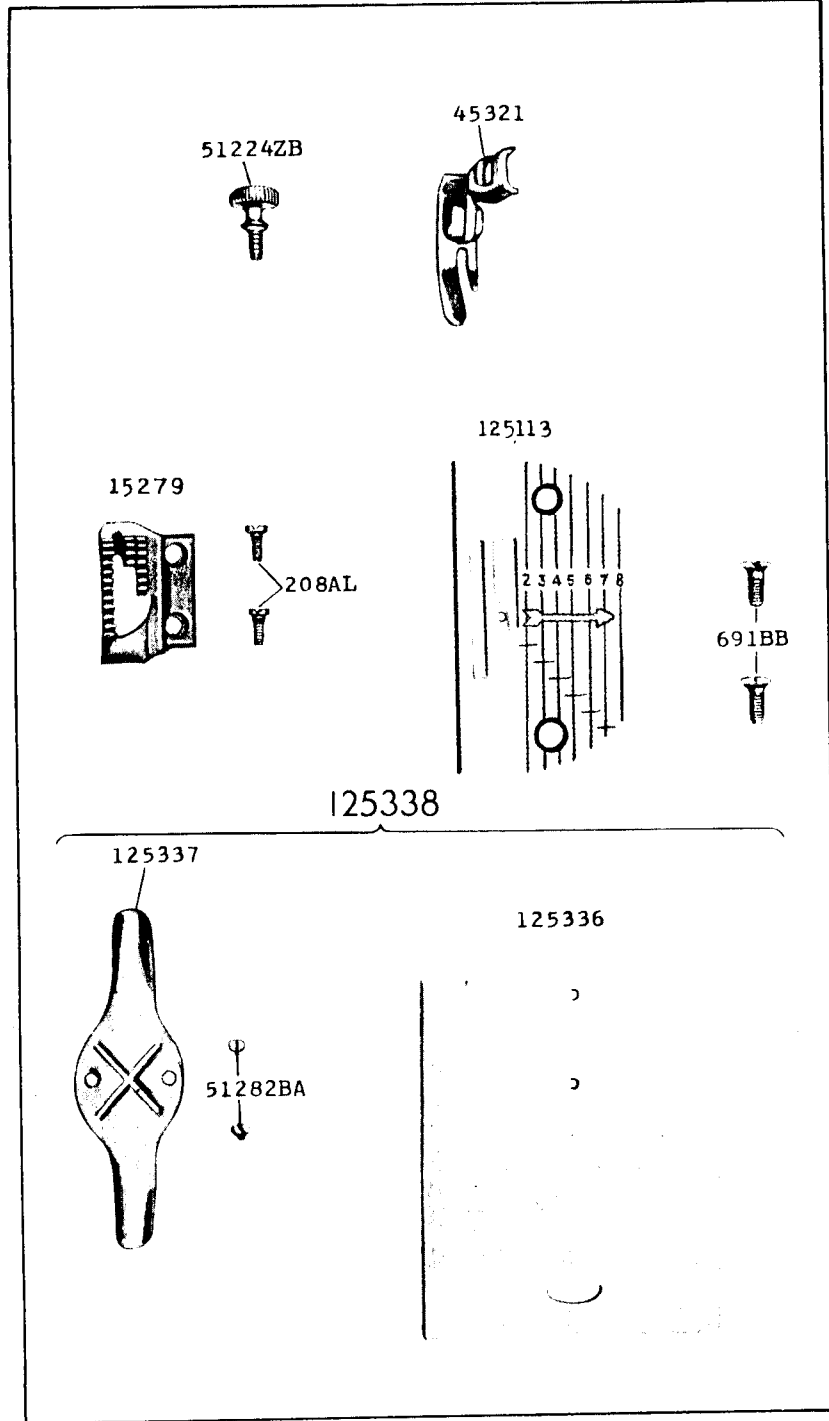

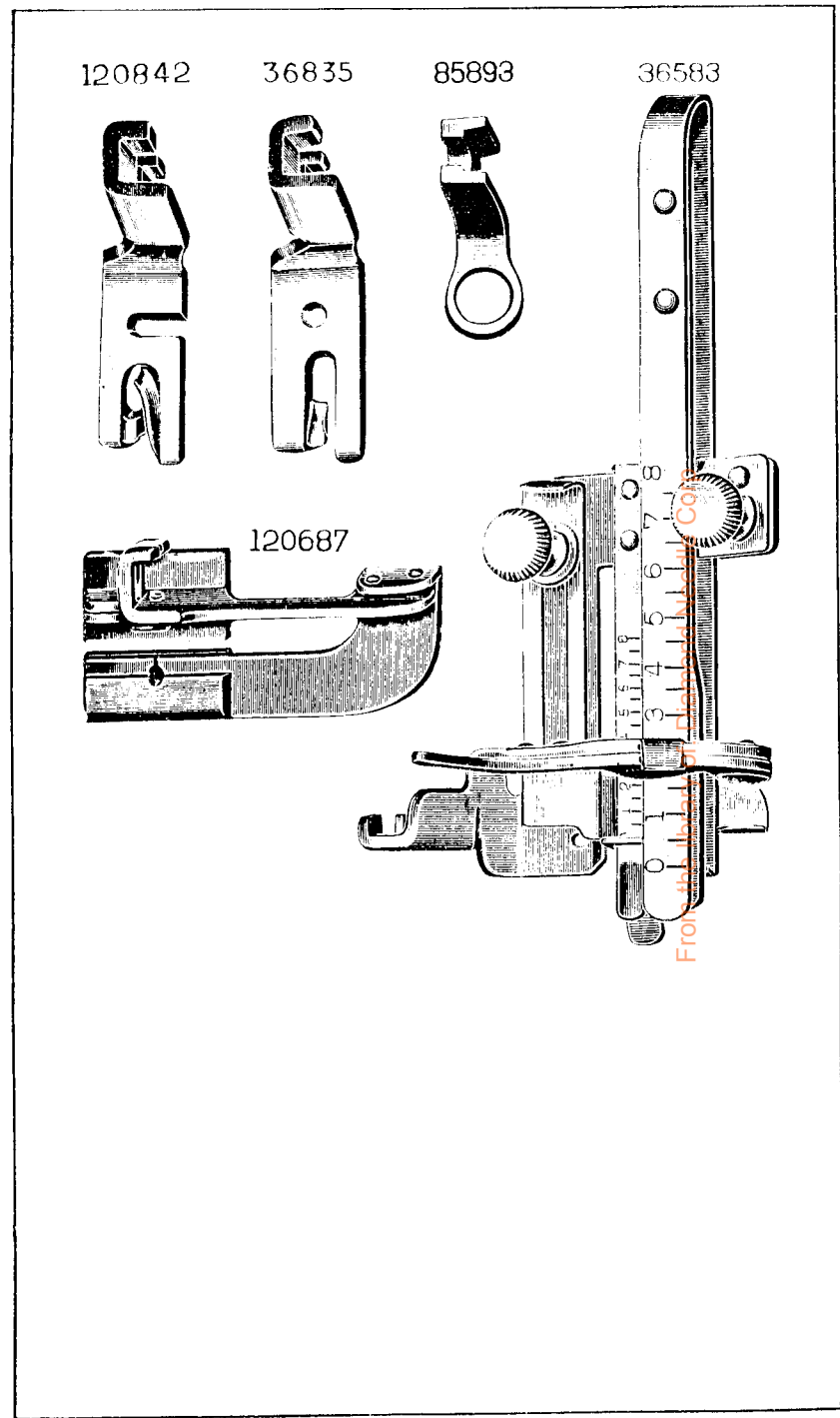
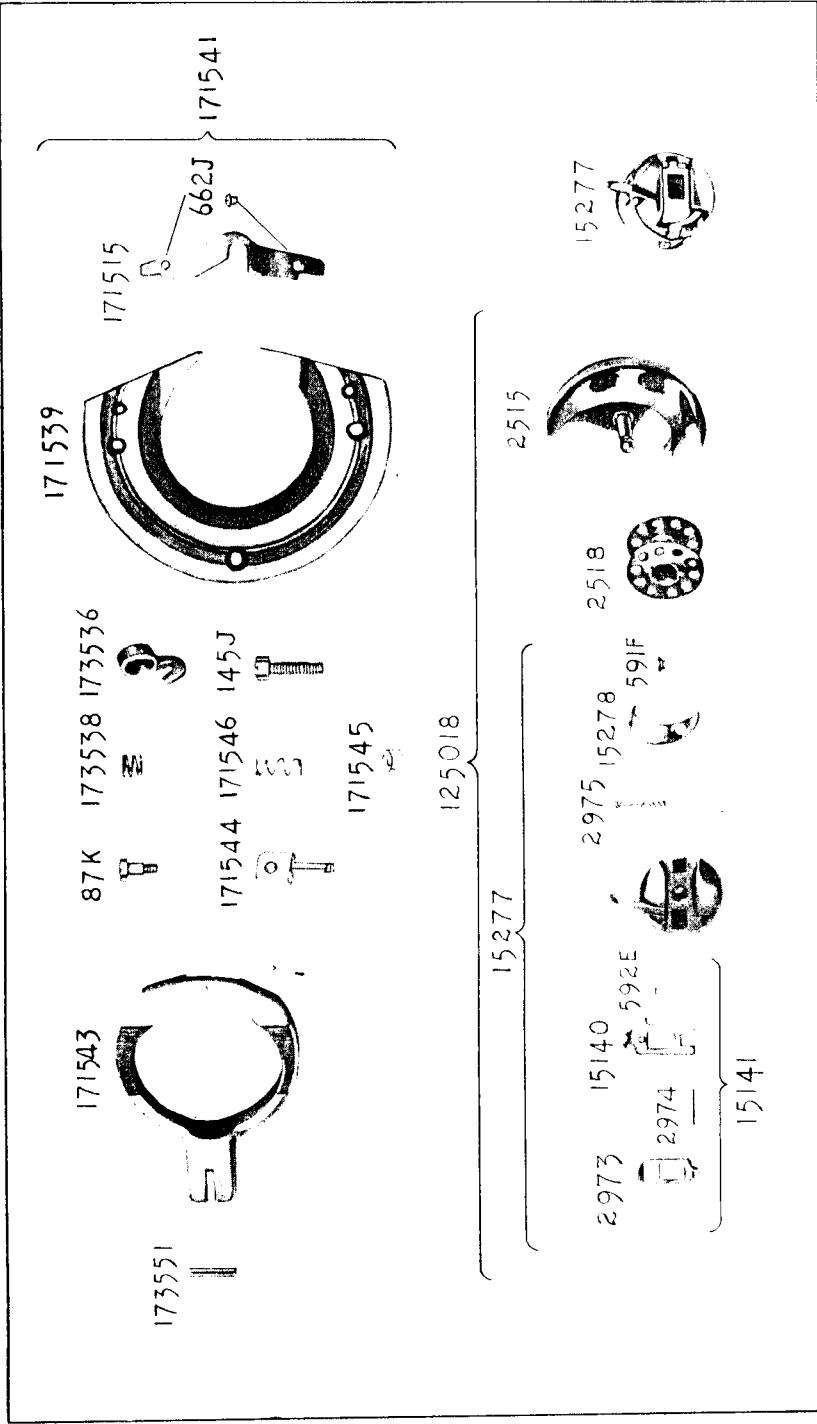

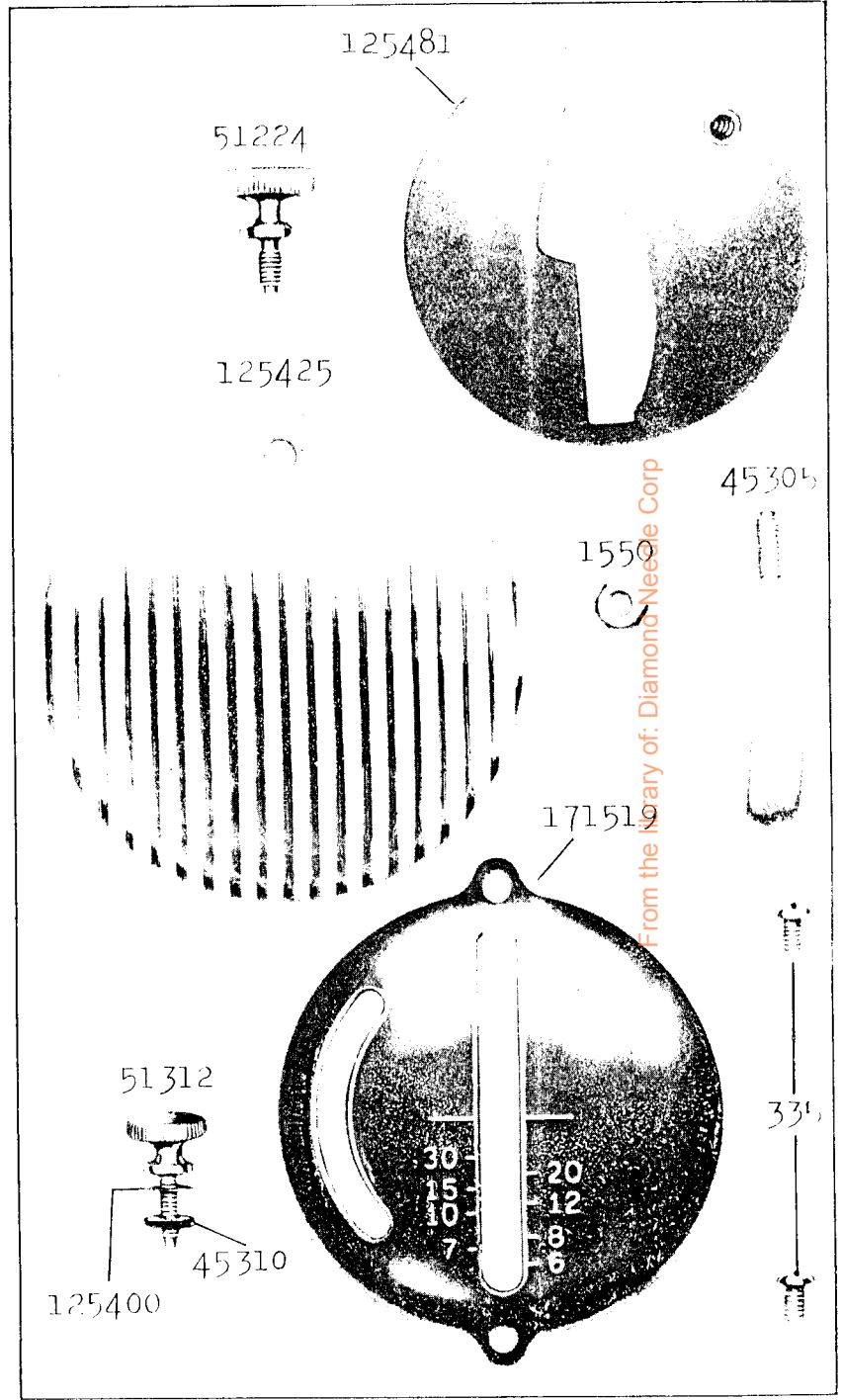
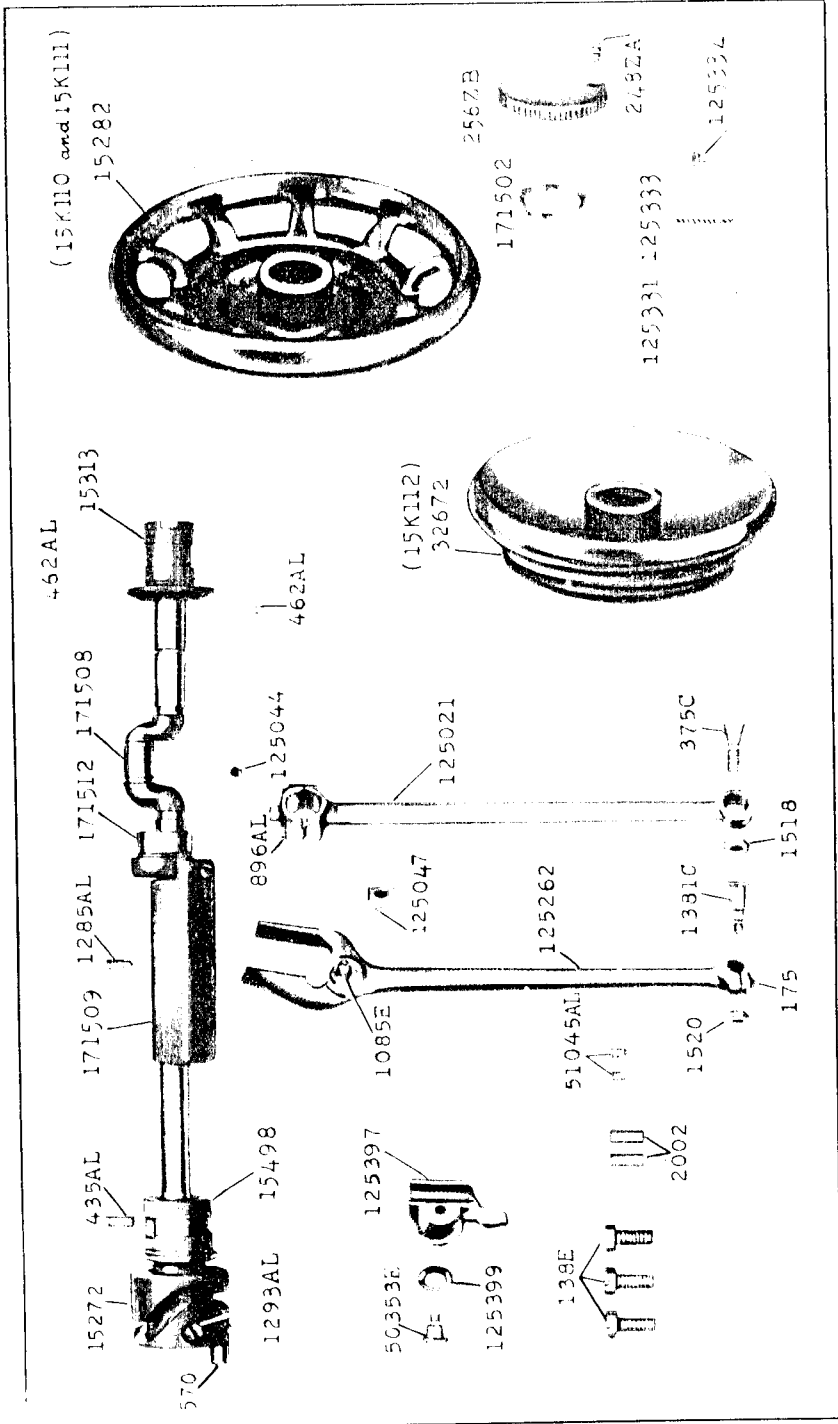

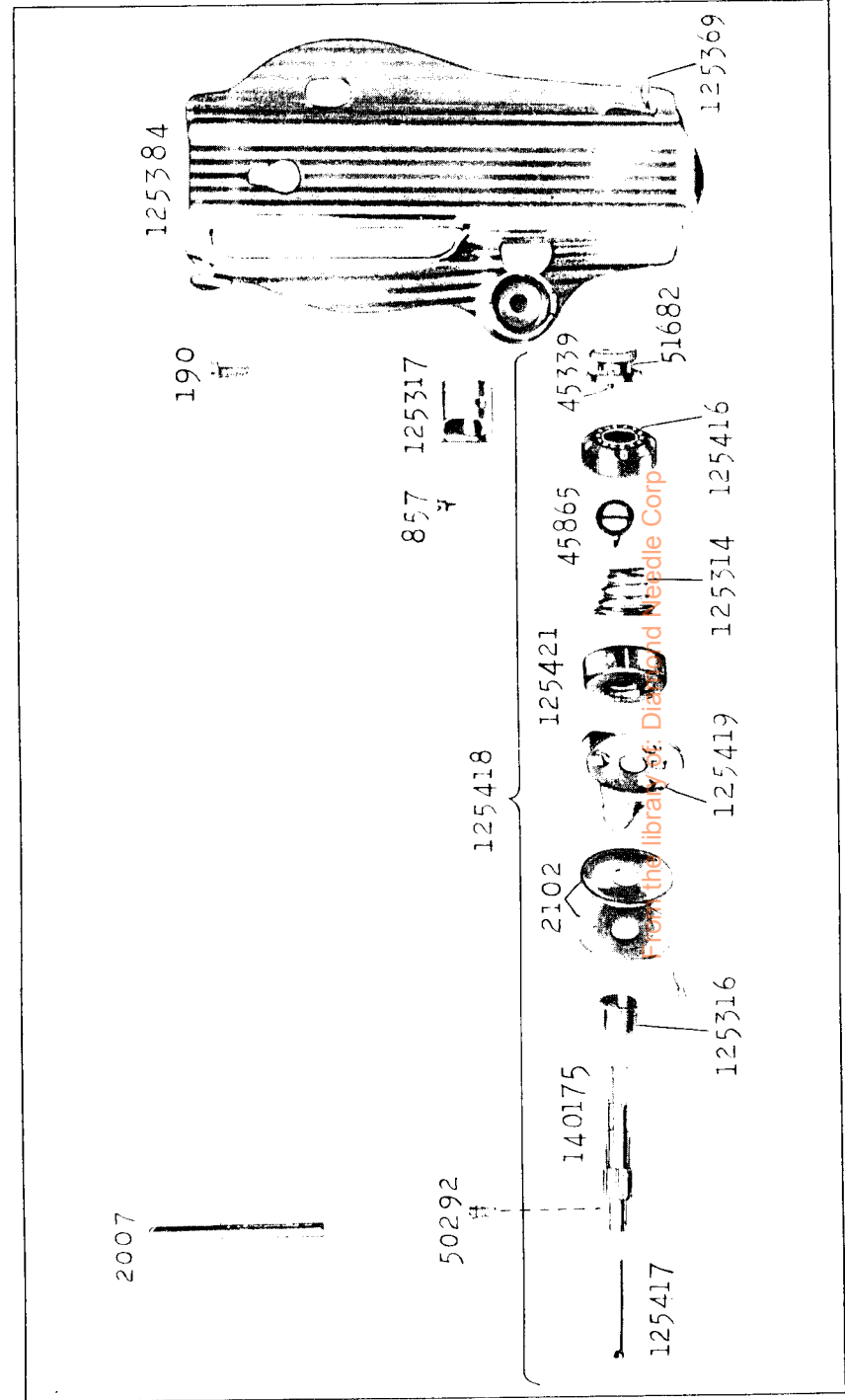
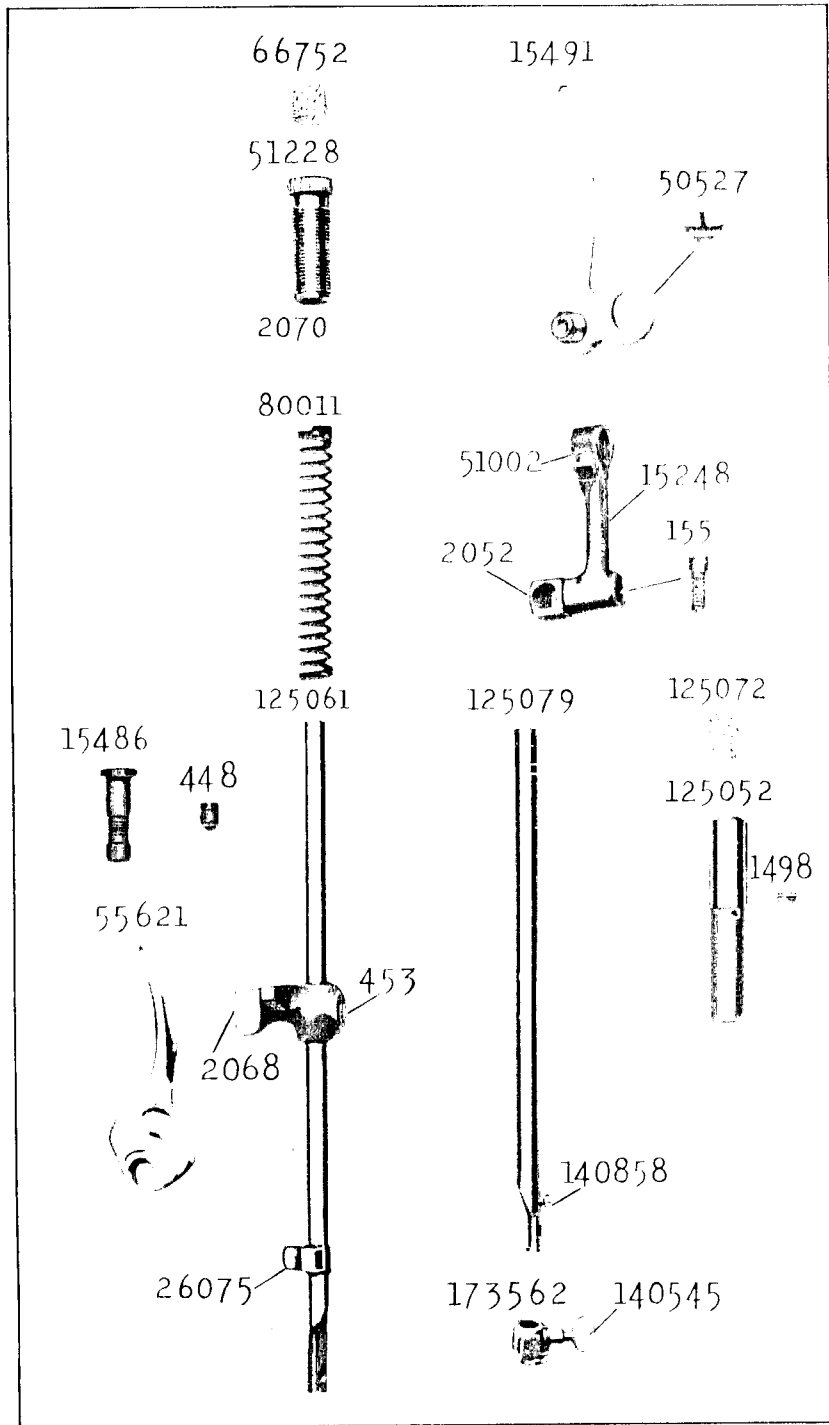

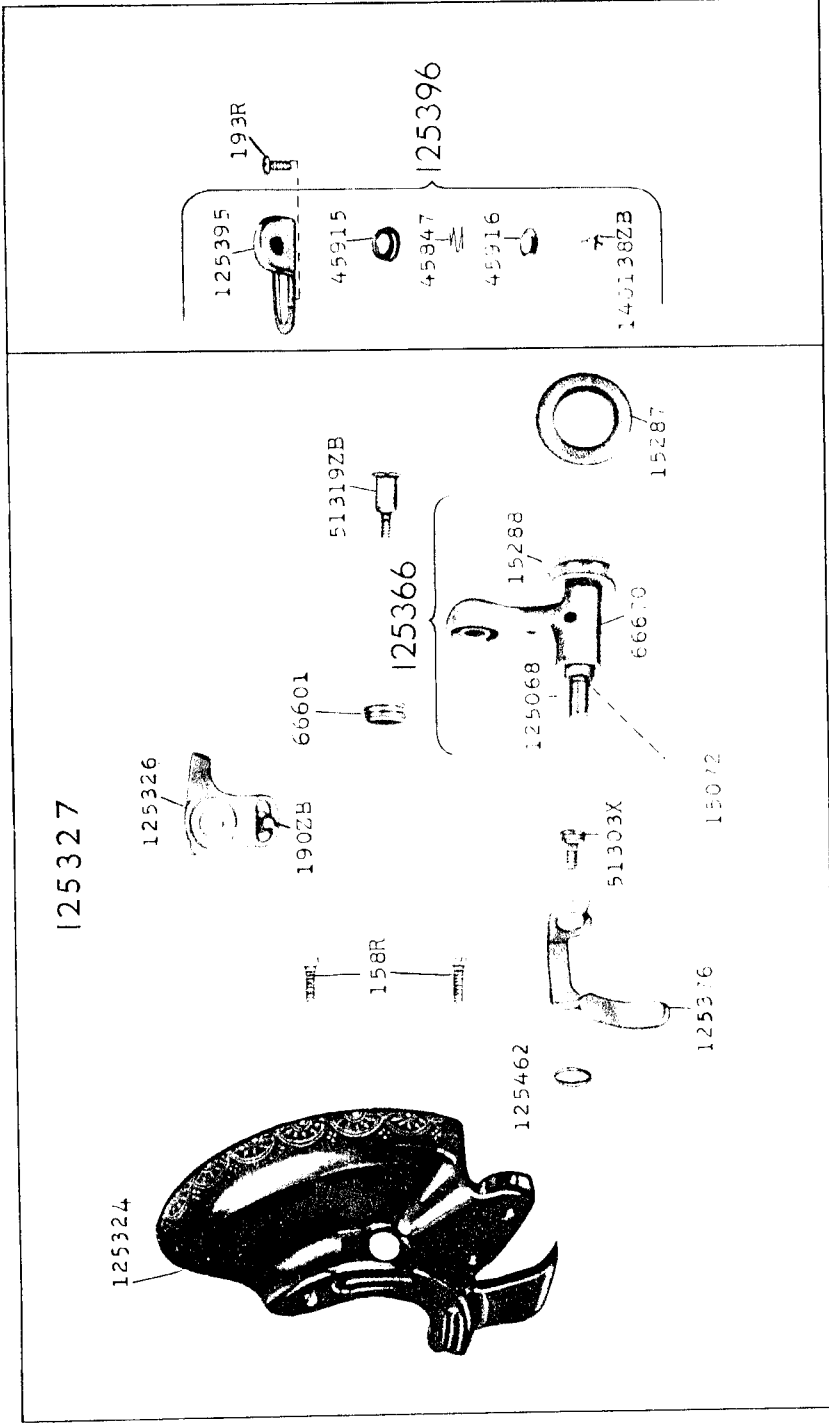

LIST OF PARTS
FOR
15K110 to 15K112 Machines

CONTENTS

	Page
Parts complete for 15K110 to 15K112 Machines	25
Attachments	32
Bobbin Winder	31
Embroidery Hoops	34
Hand Attachment	36
Numerical List of Parts	39

From the library of: Diamond Needle Corp

INSTRUCTIONS FOR ORDERING

In ordering from this List the prefix and affix letters with the part number MUST BE quoted exactly as they are shown in the first column.

A number always indicates the same part in whatever List it may appear, or for whatever machine.

The affix letters and code numbers (where shown) indicate the style of finish, as follows:—

New Code	Old Code	Description
801	A.	Hardened, Polished, Nickel Plated and Buffed.
802	B.	Polished, Nickel Plated and Buffed.
803	C.	Hardened only.
804	D.	Polished only.
805	E.	Soft, Not Polished.
806	F.	Hardened and Polished.
807	G.	Bright Rumbled and Nickel Plated.
808	H.	Blued.
809	J.	Nickel Plated only.
810	K.	Hardened and Nickel Plated.
811	L.	Brass Plated.
812	M.	Oxidized.
813	R.	Phosphate Coating Formed on Surface of Iron or Steel.
814	S.	Cadmium Plated.
815	T.	Copper Plated.
816	U.	Zinc Plated.
817	V.	Silver Plated.
818	W.	Polished and Nickel Plated.
819	X.	Black Oxide for Iron and Steel.
820	Y.	Black Nickel Plated only.
821	Z.	Chromium Plated.
822	A.A.	Buffed and Chromium Plated.
823	A.B.	Hardened, Polished, Buffed and Chromium Plated.
824	A.E.	Hardened, Bright Rumbled and Nickel Plated.
825	A.F.	Hardened, Bright Rumbled, Nickel Plated, Bright Rumbled and Chromium Plated.
826	A.G.	Alumilite (Plain). Colour must be stated.
827	A.H.	Alumilite (Dyed). Colour must be stated.
828	A.J.	Polished, Nickel Plated and Chromium Plated.
829	A.K.	Hardened, Polished, Nickel Plated and Chromium Plated.
830	A.L.	Heat Treated for Toughness.
831	A.L.D.	Heat Treated for Toughness and Polished.
832	A.L.J.	Heat Treated for Toughness and Nickel Plated.
833	A.L.X.	Heat Treated for Toughness and Black Oxide.
834	A.L.Z.B.	Heat Treated for Toughness, Polished, Nickel Plated, Buffed and Chromium Plated.
835	A.S.	Black Moulded Phenolic.
836	A.T.	Beige Moulded Phenolic.
837	A.U.	Brown Moulded Phenolic.
838		
839	B.A.	Chrome Nickel, Satin Finish.
840	B.B.	Hardened and Chrome Nickel, Satin Finish.
841	C.R.	Hardened and Phosphate Coating Formed on Surface of Steel.
842	C.U.	Hardened and Zinc Plated.
843	F.J.	Hardened, Polished and Nickel Plated.
844	T.A.	Hardened, Polished, Copper and Nickel Plated and Buffed.
845	T.B.	Copper and Nickel Plated and Polished.
846	T.J.	Copper and Nickel Plated only.
847	T.K.	Hardened, Copper and Nickel Plated.
848	T.L.	Copper and Brass Plated.
849	T.M.	Copper Plated and Oxidized.
850	X.C.	Hardened and Black Oxide for Iron and Steel.
851	Z.A.	Hardened, Polished, Nickel Plated, Buffed and Chromium Plated.
852	Z.B.	Polished, Nickel Plated, Buffed and Chromium Plated.
853	Z.C.	Hardened and Chromium Plated.
854	Z.D.	Polished and Chromium Plated.
855	Z.G.	Bright Rumbled, Nickel Plated, Bright Rumbled and Chromium Plated.
856	Z.J.	Nickel and Chromium Plated.
857	Z.T.	Copper and Chromium Plated.
858	A.L.Z.J.	Heat Treated for Toughness, Nickel and Chromium Plated.

Parts marked with an asterisk (*) are furnished only when the repairs are made at Factory.

PARTS COMPLETE

FOR

15K110 to 15K112 MACHINES

Lock Stitch ; G.B. Oscillating Shuttle ; Reversible Feed ; Cam Take-up ;
Feed Throw-out Device for Darning and Embroidery.
For Family Use.

No.	Plate	Description
*80310		Arm
<i>NOTE: Arm cannot be supplied separately and can only be sent out as a unit, Arm and Bed assembled.</i>		
171507		Arm and Bed, with Nos. 125331, 125333, 125334 and four 140543L
2002	2822	" Dowel Pin (2)
125331	2822	" Oil Pad (felt), for oiling Arm Shaft Back Bearing ...
125333	2822	" " " Spring
125334	2822	" " " " Cap
138c	2822	" Screw (3)
15197		" Shaft
171508	2822	" " 15197 with 15434, 15498, 171509 and 171512 ...
15498	2822	" " Bushing
435c	2822	" " " Set Screw
171509	2822	" " Counterbalance with 1285al
1285al	2822	" " " Position Screw
125425	2823	" Side Cover
51224zb	2823	" " " Thumb Screw
2007zg	2825	" Spool Pin
*173602		Bed
<i>NOTE:--Bed cannot be supplied separately and can only be sent out as a unit, Arm and Bed assembled.</i>		
256zb	2822	Clamp Stop Motion Clamp Screw
248za	2822	" " " " Stop Screw
171502	2822	" " " " Washer
*15312		" " " " Flanged Bushing
15313	2822	" " " " " 15312 with two 462al ...
2022		" " " " " Pin
462al	2822	" " " " " Set Screw
15314		Clamp Stop Motion, complete, Nos. 248za, 256zb, 15313 and 171502 (for Agents only)
125021u	2822	Crank Connecting Rod with 125044 and two 896al ...
896al	2822	" " " " Cap Screw
375c	2822	" " " " Hinge Screw
1518u	2822	" " " " " Nut
125044	2822	" " " " Oil Pad (felt)

From the library of: Diamond Needle Corp.

No.	Plate				
*125367	-	Face Plate
125384	2825	" "	125367 with 15410, 125258 and 125369
125368	-	" "	125384 with 857zb, 50202zb and 125317j
125258	-	" "	Tension Seat
125428	-	" "	Thread Guard
125369	2825	" "	" "	125428 with 125373 (for Agents only)	...
125373	-	" "	" "	Rivet	...
125412	-	Face Plate, complete, Nos. 125368 and 125418
190zj	2825	" "	" "	Screw	...
173508en	2818	Feed Bar
1904	2818	" "	Roller
1813	-	" "	" "	and Stud, Nos. 1904 and 125060	...
*125060	-	" "	" "	Stud	...
315c	2818	" "	" "	Screw Centre	...
15445	-	" "	" "	315c with 1519u (2)	...
1519u	2818	" "	" "	Nut	...
171512	2822	Feed Cam with 1285al
1285al	2822	" "	" "	Position Screw	...
15279	2817	Feed Dog, 12 teeth (14 teeth to the inch)
208al	2817	" "	" "	Screw (2)	...
125262u	2822	Feed Forked Connection with 175u
12534c	-	" "	" "	125262u with 125335	...
175u	2822	" "	" "	Adjusting Screw	...
1381c	2822	" "	" "	Hinge Screw (eccentric)	...
1520u	2822	" "	" "	" "	Nut
125047	2822	" "	" "	Slide Block	...
125335	-	" "	" "	" "	125047 with 1085c
1085e	2822	" "	" "	" "	Screw Stud
173510u	2818	Feed Lifting Rock Shaft
173511	-	" "	" "	" "	with Feed Throw-out Assembly, complete, Nos. 173510u, 173513 and 173520u
173512	2818	Feed Lifting Rock Shaft Crank with 704u and 50150al
704u	2818	" "	" "	" "	Clamping Screw
173513	-	Feed Lifting Rock Shaft Crank with Feed Throw out Lever, complete, Nos. 173512 and 173515 to 173517
125048c	2818	Feed Lifting Rock Shaft Centre (left)
125049c	2818	" "	" "	" "	(right)
51246al	2818	" "	" "	" "	Set Screw (2)

No.	Plate				
125397	2822	Feed Regulator
125398	-	" "	" "	125397 with 125381	...
50353e	2822	" "	" "	Hinge Screw	...
125399	2822	" "	" "	" "	Washer
45305	2823	Feed Reversing Handle
125381	-	" "	" "	" "	45305 with 1550r
1550r	2823	" "	" "	" "	Lock Nut
125270	2818	Feed Rock Shaft
125048c	2818	" "	" "	" "	Centre (left)
125049c	2818	" "	" "	" "	(right)
51246al	2818	" "	" "	" "	Set Screw (2)
173514	2818	Feed Throw-out Knob with 442al
442al	2818	" "	" "	" "	Set Screw
173517	2818	" "	" "	" "	Shaft and Bobbin Winder Spool Pin
173515	2818	" "	" "	" "	Lever with 1813
173516	2818	" "	" "	" "	Tension Spring
173517u	2818	" "	" "	" "	" "
50150al	2818	" "	" "	" "	" "
173518u	2818	" "	" "	" "	" "
21202u	2818	" "	" "	" "	" "
140138u	2818	" "	" "	" "	" "
173519u	2818	" "	" "	" "	" "
173520u	2818	" "	" "	" "	" "
15282	2822	Hand Wheel, 2 1/4" pulley, for 15K110 and 15K111 Machines
32672	2822	" "	" "	" "	3 1/4" pulley, for 15K112 Machine
120842	2821	Hemmer (foot) 5/64" hem (packed with accessories)
51045al	2822	Machine Hinge Connection Set Screw (2)
15x1	-	Needle, size 14
125079	2824	Needle Bar
125052	2824	" "	" "	" "	Bushing
125072	2824	" "	" "	" "	Oil Pad (felt)
1498al	2824	" "	" "	" "	Set Screw
*15248	2824	" "	" "	" "	Connecting Link with 51002e
15374	-	" "	" "	" "	15248 with 2652
51002e	2824	" "	" "	" "	Adjusting Screw
570c	2822	" "	" "	" "	Hinge Screw
1520r	2822	" "	" "	" "	" "
2052	2824	" "	" "	" "	Stud with 155c
155c	2824	" "	" "	" "	Set Screw

No.	Plate					
2054	-	Needle Clamp with 140545c
171549	-	" " Thread Guide
251za	-	" " " " and Needle Stop Screw
140545c	2824	" " Thumb Screw
140543L	-	Number Plate Drive Screw
125055u	2818	Oscillating Rock Shaft with 125056
125048c	2818	" " " Centre (left)
51246al	2818	" " " " (") Set Screw
125049c	2818	" " " " (right)
51246al	2818	" " " " (") Set Screw
125056	2818	" " " Oil Wick (braided cotton)
2510u	2818	Oscillating Shaft
*125063	---	" " 2510u with 2C49 and 125062cu
*125086	---	" " 125063 with 125058, 125065 and two 51229e
*125057u	---	" " Crank
*125058	-	" " 125057u with 462al and 125330
125059	2818	" " 125057u with 125330 and two 462al
2049	-	" " " Pin
462al	2818	" " " Set Screw
*15170	-	" " " Slide Block
125330	2818	" " " " 15170 with 125060
*125060	---	" " " " Stud
125061	2824	Presser Bar
2068	2824	" " Guide Bracket with 453al
453al	2824	" " " " Set Screw
55621	2824	" " Lifter
15486	2824	" " " Hinge Stud
448al	2824	" " " " Set Screw
80011	2824	" " Spring
2070	2824	" " " Washer
45329	---	Presser Foot Hinge Pin
*45319	---	" " Plate
*32774	---	" " Shank
45321	2817	Presser Foot (hinged), complete, Nos. 32774, 45319 and 45329
51224zb	2817	" " Thumb Screw
*51228zb	2824	Pressure Regulating Thumb Screw
66773	---	" " " " 51228zb with 66752
66752	2824	" " " Plug (felt)

No.	Plate					
2518	2820	Shuttle Bobbin (5) (1 in machine, 4 packed with accessories)
15140	2820	" " Case Latch
2973	2820	" " " " Lever
2974	2820	" " " " " Fulcrum Pin
2975	2820	" " " " Spring
592e	2820	" " " " Stop Screw
15141	2820	" " " Hinge, Nos. 2973, 2974 and 15140
15277	2820	" " " Nos. 592e, 2975 and 15141
2515	2820	" Body
591f	2820	" Tension Regulating Screw
15278	2820	" Spring
125018	2820	Shuttle, 1 1/16" diam., complete, Nos. 2515, 2518 and 15277
*125062cu	-	Shuttle Driver
125092	2818	" " 125062cu with two 462al
125064	-	" " 125092 with 125065 and two 51229e (for Agents only)
125065	2818	" " Cushion Spring
51229e	2818	" " " " Screw
2049	---	" " Pin
462al	2818	" " Set Screw
171539	2820	Shuttle Race Body
171540	-	" " " 171539 with 171515 and two 662j (for Agents only)
171515	2820	" " Cap
662j	2820	" " " Screw
171541	2820	Shuttle Race, complete, Nos. 171515, 171539, 171543 to 171546, 173551, two each 87k, 662j, 173536 and 173538
171542	-	Shuttle Race, complete, Nos. 2515, 171515, 171539, 171543 to 171546, 173551, two each 87k, 662j, 173536 and 173538 (for Agents only)
171543	2820	Shuttle Race Gate
173551	2820	" " " Hinge Pin
171544	2826	" " " " Stud
171545	2820	" " " " " Nut
171546	2820	" " " " " Spring
173536	2820	" " " Latch
87k	2820	" " " " Screw
173538	2820	" " " " Spring
145j	2820	" " " Screw (2)
125336	2817	Shuttle Race Slide
125337	2817	" " " Spring
51282zj	2817	" " " Screw

No.	Plate	
125338	2817	Shuttle Race Slide , complete, Nos. 125336, 125337 and two 51282zj
171519	2823	Stitch Indicator Plate
335zb	2823	" " " Screw (2)
125481	2823	" Regulating Plate
171520	-	" " " 125481 with 45310, 51312zb, 125400 and 171519
51312zb	2823	" " Thumb Screw
125400	2823	" " " " Friction Washer
45310	2823	" " " " Washer (fibre)
2102	2825	Tension Disc
125421	2825	" Indicator
125416	2825	" " Flange
45865	2825	" " " Stop Washer
51682zb	2825	" Regulating Thumb Nut with 45339
45339	2825	" " " " Engaging Pin
125417	2825	" Releasing Pin
125314	2825	" Spring
140175zj	2825	" Stud
125420	-	" " 140175zj with 51682zb
15410	-	" " Bushing
50292zb	2825	" " Set Screw
125418	2825	Tension , complete, Nos. 45865, 125314, 125316, 125416, 125417, 125419 to 125421 and two 2102
26075	2824	Thread Cutter and Holder
15272	2822	Thread Take-up Cam with 1293al
*15434	-	" " " " 15272 with 570c and 1526r
1293al	2822	" " " Timing Screw
15491	2824	Thread Take-up Lever with 1822
15492	-	" " " 15491 with 50527c
50527c	2824	" " " Hinge Screw
1822	-	" " " Roller and Stud
125316	2825	Thread Take-up Spring
125317j	2825	" " " Regulator
857zb	2825	" " " " Set Screw
125419	2825	" " " Thread Guard
125113	2817	Throat Plate
691za	2817	" " " Screw (2)
140543L	-	Trademark Screw

Bobbin Winder

for Hand Wheel No. 15282 or No. 32672

No.	Plate	
†125324	2826	Bracket (belt cover)
158j	2826	" " Screw (2)
66670	2826	Frame
125366	2826	" 66670 with 15288 and 125068
51319r	2826	" Hinge Screw
66601	2826	" Spring
15287	2826	Friction Ring (rubber)
15288	2826	Pulley
125068	2826	Spindle
125376	2826	Stop Latch
51303r	2826	" " Hinge Screw
125462	2826	" " Spring
125395	2826	Tension Bracket
125396	2826	" " " complete, Nos. 45847, 45915, 45916, 125395 and 140138zb
193b	2826	" " " Screw
45915	2826	" Disc
45916	2826	" " " Screw Washer
45847	2826	" " " Spring
140138zb	2826	" " " Screw
125326	2826	Tripping Arm
190r	2826	" " " Screw
†125327	2826	Bobbin Winder (automatic), complete, Nos. 190r, 15287, 51303r, 51319r, 66601, 125324, 125326, 125366, 125376 and 125462

* In ordering it is necessary to state Class of Machine.

Attachments

Attachment Set No. 161324 (Packed in Cardboard Box)

(For All Countries except Denmark, Norway, Sweden and Switzerland)

No.	Plate	
121464	2574	Binder
25527b	2719	Cloth Guide
50053b	2719	" " Thumb Screw
121441	2574	Gathering Foot (double toe)
161307	---	Needle Threader (wire)
15 × 1	---	Needles, three each sizes 11 and 14
161127	2719	Presser Foot (binged, adjustable) for sewing on the right or left side of the needle, for Edge Stitching, Cording and Slide Fastener Work
86742	2574	Ruffler
161294	2574	Screw Driver (machine)
161295	2574	" " (bobbin case) (120378 will be supplied until stock is exhausted)
8879	2574	Spool Pin Washer (cloth)
120861	---	Tin of Oil (3 oz.)
161324	---	Attachment Set, complete, Nos. 25527b, 50053b, 86742, 120861, 121441, 121464, 161127, 161294, 161295, 161307, two 8879 and six needles 15 × 1 (three each sizes 11 and 14)

Attachment Set No. 161325 (Packed in Cardboard Box)

(For Denmark, Norway, Sweden and Switzerland)

This is the same as Set No. 161324 with the following addition :

121094	2719	Darning Foot (spring)
161325	---	Attachment Set, complete, Nos. 25527b, 50053b, 86742, 120861, 121094, 121441, 121464, 161127, 161294, 161295, 161307, two 8879 and six needles 15 × 1 (three each sizes 11 and 14)

Fashion Aids

Available for separate purchase.

No.	Plate	
25525	2719	Bias Gauge
86649	---	Blind Stitch Attachment
86718	---	Buttonhole Attachment
121094	2719	Darning Foot (spring)
36865	2574	Edge Stitcher
85893	2821	Embroidery Foot (for art work)
36835	2821	Feller Foot
35931	2574	Hemmer (adjustable)
120687	2821	Imitation Hemstitching Attachment with Yielding Presser Plate
160845	2719	Presser Foot (left toe) for Edge Stitching, Cording and Slide Fastener Work
160846	2719	Presser Foot (right toe) for Edge Stitching, Cording and Slide Fastener Work
35932	2719	Quilter
121170	909	Ruffler Shirring Plate
25539	2719	Stiletto... ..
36583	2821	Tucker
121547	909	Under Braider

Embroidery Hoops (Plain)

(Birch)

No.	Plate	
101336	---	Hoop (inner)
101337	---	" (outer)
87586	---	" (round) 5 $\frac{3}{8}$ " diam. \times 7 $\frac{m}{m}$ high, Nos. 101336 and 101337 ...
101346	---	" (inner)
101347	---	" (outer)
96416	---	" (round) 7" diam. \times 7 $\frac{m}{m}$ high, Nos. 101346 and 101347 ...
101338	---	" (inner)
101339	---	" (outer)
87589	2659	" (round) 8" diam. \times 7 $\frac{m}{m}$ high, Nos. 101338 and 101339 ...
101340	---	" (inner)
101341	---	" (outer)
87593	---	" (round) 10" diam. \times $\frac{7}{16}$ " high, Nos. 101340 and 101341 ...
101342	---	" (inner)
101343	---	" (outer)
87595	---	" (round) 12" diam. \times $\frac{1}{2}$ " high, Nos. 101342 and 101343 ...
101358	---	" (inner)
101359	---	" (outer)
96422	2659	" (oval) 9" \times 4 $\frac{1}{2}$ " \times 7 $\frac{m}{m}$ high, Nos. 101358 and 101359 ...
101344	---	" (inner)
101345	---	" (outer)
87597	---	" (oval) 12" \times 5 $\frac{1}{2}$ " \times 7 $\frac{m}{m}$ high, Nos. 101344 and 101345 ...

Embroidery Hoop (With Spring)

(Birch)

No.	Plate	
101364	---	Hoop (inner) for 101246
101365	---	" (outer) with Spring, for 101246
101246	---	" (round) 10" diam. \times $\frac{7}{16}$ " high, Nos. 101364 and 101365 ...

Embroidery Hoops (With Clamp)

(Birch)

No.	Plate	
101348	---	Hoop (inner)
101349	---	" (outer) with SS528j, NN95j, two 96425 and four 96427 ...
96417	---	" (round) 5 $\frac{3}{8}$ " diam. \times 7 $\frac{m}{m}$ high, Nos. 101348 and 101349 ...
101350	---	" (inner)
101351	---	" (outer) with SS528j, NN95j, two 96426 and four 96427 ...
96418	2659	" (round) 7" diam. \times 7 $\frac{m}{m}$ high, Nos. 101350 and 101351 ...
101352	---	" (inner)
101353	---	" (outer) with SS528j, NN95j, two 96426 and four 96427 ...
96419	---	" (round) 8" diam. \times 7 $\frac{m}{m}$ high, Nos. 101352 and 101353 ...
101354	---	" (inner)
101355	---	" (outer) with SS528j, NN95j, two 96426 and four 96427 ...
96420	---	" (round) 10" diam. \times $\frac{7}{16}$ " high, Nos. 101354 and 101355 ...
101356	---	" (inner)
101357	---	" (outer) with SS528j, NN95j, two 96844 and four 96845 ...
96421	---	" (round) 12" diam. \times $\frac{1}{2}$ " high, Nos. 101356 and 101357 ...
101360	---	" (inner)
101361	---	" (outer) with SS528j, NN95j, 96425, 96426 and four 96427 ...
96423	---	" (oval) 9" \times 4 $\frac{1}{2}$ " \times 7 $\frac{m}{m}$ high, Nos. 101360 and 101361 ...
101362	---	" (inner)
101363	---	" (outer) with SS528j, NN95j, 96425, 96426 and four 96427 ...
96424	---	" (oval) 12" \times 5 $\frac{1}{2}$ " \times 7 $\frac{m}{m}$ high, Nos. 101362 and 101363 ...
96425	2399	Clamping Bracket for 101349, 101361 and 101363 ...
96426	2399	" " " 101351, 101353, 101355, 101361 and 101363 ...
96844	2399	" " " 101357
96427	2399	" " Rivet for 101349, 101351, 101353, 101355, 101361 and 101363 ...
96845	2399	" " " " 101357
SS528j	2399	" " Screw
NN95j	2399	" " Nut

From the library of Diamond Needle Club

Hand Attachment

No.	Plate						
†94050	2284	Body
†94027	2284	" Bracket
183e	2114	" " Screw
†94028	2114	Crank Handle
94029b	2114	" " Spindle
94069	2114	" Hinge Pin
94031za	2284	" Lever
94032	2114	" " Lock Pin
94033zb	2114	" " " " Head
55531	2114	" " " " Spring
94034b	-	Crank, complete, Nos. 94028, 94029b and 94031za
†94046	2114	Driver
94070	-	" 94046 with 80028 and 94048
94036	2114	" Finger
94039	2114	" " Driving Pad (raw-hide)
94040	2114	" " " " Plate
SS567e	2114	" " " " and Plate Binding Screw
94041	-	" " 94036 with SS567e, 94039 and 94040
94044	2114	" " Hinge Pin
94037	2114	" " Latch
SS565e	2114	" " " Screw Stud
94038	2114	" " " Spring
†94051	2284	Gear with 55531, 94032 and 94033zb
†94016	2284	" Cover
399za	2114	" " Screw
SS599f	2114	" Screw Stud
94048	2114	Pinion
80028	2114	" Dowel Pin
SS600f	2114	" Screw Stud (eccentric)
†94052	2284	Hand Attachment, complete, Nos. SS565e, SS566e, SS599f, SS600f, 94016, 94027, 94034b, 94037, 94038, 94041, 94044, 94050, 94051, 94069, 94970, two each 183e and 399za
SS566e	2114	Hand Attachment Screw

† As the Hand Attachment is used on Coloured Machines of other classes it is necessary to state Colour of Machine.

Numerical List of Parts

No.	Plate						
87k	2820	Shuttle Race Gate Latch Screw for 171511 and 171542
NN95j	2399	Embroidery Hoop Clamping Bracket Screw Nut for 101349, 101351, 101353, 101355, 101357, 101361 and 101363
138e	2822	Arm Screw
145j	2820	Shuttle Race Screw
155c	2824	Needle Bar Connecting Stud Set Screw for 2052
158j	2826	Bobbin Winder Bracket Screw
175u	2822	Feed Forked Connection Adjusting Screw for 125262u
183e	2114	Hand Attachment Body Bracket Screw for 94052
190r	2826	Bobbin Winder Tripping Arm Screw for 125327
190zj	2825	Face Plate Screw
193b	2826	Bobbin Winder Tension Bracket Screw
208al	2817	Feed Dog Screw
248za	2822	Clamp Stop Motion Clamp Stop Screw for 15314
251za	—	Needle Clamp Thread Guide and Needle Stop Screw
256zb	2822	Clamp Stop Motion Clamp Screw for 15314
315c	2818	Feed Bar Screw Centre for 15445
335zb	2823	Stitch Indicator Plate Screw
375c	2822	Crank Connecting Rod Hinge Screw
399za	2114	Hand Attachment Gear Cover Screw for 94052
435c	2822	Arm Shaft Bushing Set Screw
442al	2818	Feed Throw-out Knob Set Screw for 173514
448al	2824	Presser Bar Lifter Hinge Stud Set Screw
453al	2824	Presser Bar Guide Bracket Set Screw for 2068
462al	2822	Clamp Stop Motion Flanged Bushing Set Screw for 15313
462al	2818	Oscillating Shaft Crank Set Screw for 125058 and 125059
462al	2818	Shuttle Driver Set Screw for 125092
SS528j	2399	Embroidery Hoop Clamping Bracket Screw for 101349, 101351, 101353, 101355, 101357, 101361 and 101363
SS565e	2114	Hand Attachment Driver Finger Latch Screw Stud for 94052
SS566e	2114	Hand Attachment Screw for 94052

No.	Plate	
SS567e	2114	Hand Attachment Driver Finger Driving Pad and Plate Binding Screw for 94041 ...
570c	2822	Needle Bar Connecting Link Hinge Screw for 15434 ...
591f	2820	Shuttle Tension Regulating Screw ...
592e	2820	Shuttle Bobbin Case Latch Stop Screw for 15277 ...
SS599f	2114	Hand Attachment Gear Screw Stud for 94052 ...
SS600f	2114	Hand Attachment Pinion Screw Stud (eccentric) for 94052 ...
662j	2820	Shuttle Race Cap Screw for 171540 to 171542
691za	2817	Throat Plate Screw ...
704u	2818	Feed Lifting Rock Shaft Crank Clamping Screw for 173512 ...
857zb	2825	Thread Take-up Spring Regulator Set Screw for 125368 ...
896al	2822	Crank Connecting Rod Cap Screw for 12502In
1085e	2822	Feed Forked Connection Slide Block Screw Stud for 125335 ...
1285al	2822	Arm Shaft Counterbalance Position Screw for 171569 ...
1285al	2822	Feed Cam Position Screw for 171512 ...
1293al	2822	Thread Take-up Cam Timing Screw for 15272
1381c	2822	Feed Forked Connection Hinge Screw (eccentric)
1498al	2824	Needle Bar Bushing Set Screw ...
1518u	2822	Crank Connecting Rod Hinge Screw Nut ...
1519u	2818	Feed Bar Screw Centre Nut for 15445 ...
1520u	2822	Feed Forked Connection Hinge Screw Nut
1520r	2822	Needle Bar Connecting Link Hinge Screw Nut for 15434 ...
1550r	2823	Feed Reversing Handle Lock Nut for 125381
1813		Feed Bar Roller and Stud, Nos. 1904 and 125060 for 173515 ...
1822		Thread Take-up Lever Roller and Stud for 15491 ...
1904	2818	Feed Bar Roller for 1813 ...
2002	2822	Arm Dowel Pin ...
2007zg	2825	Arm Spool Pin ...
2022		Clamp Stop Motion Flanged Bushing Pin ...
2049		Oscillating Shaft Crank Pin for 125063 ...
2049		Shuttle Driver Pin ...
2052	2824	Needle Bar Connecting Stud with 155r for 15374 ...
2054		Needle Clamp with 140545c ...
2068	2824	Presser Bar Guide Bracket with 453al ...

No.	Plate	
2070	2824	Presser Bar Spring Washer ...
2102	2825	Tension Disc for 125418 ...
2510u	2818	Oscillating Shaft for 125063 ...
2515	2820	Shuttle Body for 125018 and 171542 ...
2518	2820	Shuttle Bobbin for 125018 (5) (1 in machine, 4 packed with accessories) ...
2973	2820	Shuttle Bobbin Case Latch Lever for 15141
2974	2820	Shuttle Bobbin Case Latch Lever Fulcrum Pin for 15141 ...
2975	2820	Shuttle Bobbin Case Latch Spring for 15277
8879	2574	Spool Pin Washer (cloth) for 161324 and 161325 ...
15140	2820	Shuttle Bobbin Case Latch for 15141 ...
15141	2820	Shuttle Bobbin Case Hinge Nos. 2973, 2974 and 15140 for 15277 ...
*15170		Oscillating Shaft Crank Slide Block for 125330 ...
*15248	2824	Needle Bar Connecting Link with 51002e, for 15374 ...
15272	2822	Thread Take-up Cam with 1293al, for 15434
15277	2820	Shuttle Bobbin Case, Nos. 592e, 2975 and 15141 for 125018 ...
15278	2820	Shuttle Tension Spring ...
15279	2817	Feed Dog, 12 teeth (14 teeth to the inch) ...
15282	2822	Hand Wheel 2 1/2" pulley, for 15K110 and 15K111 Machines ...
15287	2826	Bobbin Winder Friction Ring (rubber) for 125327 ...
15288	2826	Bobbin Winder Pulley for 125366 ...
*15312		Clamp Stop Motion Flanged Bushing for 15313 ...
15313	2822	Clamp Stop Motion Flanged Bushing 15312 with two 462al, for 15314 ...
15314		Clamp Stop Motion, complete, Nos. 248za, 256zb, 15313 and 171502 (for Agents only)
15374		Needle Bar Connecting Link 15248 with 2052
15410		Tension Stud Bushing for 125384 ...
*15434		Thread Take-up Cam 15272, with 570c and 1520r for 171508 ...
15445		Feed Bar Screw Centre 315c with 1519u ...
15486	2824	Presser Bar Lifter Hinge Stud ...
15491	2824	Thread Take-up Lever with 1822 for 15492
15492		Thread Take-up Lever 15491 with 50527c ...
15497		Arm Shaft for 171508 ...
15498	2822	Arm Shaft Bushing for 171508 ...
21202u	2818	Feed Throw-out Pitman Rod Washer ...
25525	2719	Bias Gauge ...

From the library of the University of Cambridge

No.	Plate	
25527b	2719	Cloth Guide for 161324 and 161325 ...
25539	2719	Stiletto
26075	2824	Thread Cutter and Holder
32672	2822	Hand Wheel, 31" Pulley, for 15K112 Machine
*32774		Presser Foot Shank for 45321
35931	2574	Hemmer (adjustable)
35932	2719	Quilter
36583	2821	Tucker
36835	2821	Feller (foot)
36865	2574	Edge Stitcher
45305	2823	Feed Reversing Handle for 125381
45310	2823	Stitch Regulating Thumb Screw Washer (fibre) for 171520
*45319		Presser Foot Plate for 45321
45321	2817	Presser Foot (hinged), complete, Nos. 32774, 45319 and 45329
45329	---	Presser Foot Hinge Pin for 45321
45339	2825	Tension Regulating Thumb Nut Engaging Pin for 51682zb
45847	2826	Bobbin Winder Tension Disc Spring for 125396
45865	2825	Tension Indicator Flange Stop Washer for 125418
45915	2826	Bobbin Winder Tension Disc for 125396
45916	2826	Bobbin Winder Tension Disc Screw Washer for 125396
50053b	2719	Cloth Guide and Under Braider Thumb Screw for 161324 and 161325
50150a1	2818	Feed Throw-out Lever Tension Spring Hinge Stud Set Screw for 173512
50292zb	2825	Tension Stud Set Screw for 125368
50353e	2822	Feed Regulator Hinge Screw
50527c	2824	Thread Take-up Lever Hinge Screw for 15492
51002e	2824	Needle Bar Connecting Link Adjusting Screw for 15248
51045a1	2822	Machine Hinge Connection Set Screw
51224zb	2823	Arm Side Cover Thumb Screw
51224zb	2817	Presser Foot Thumb Screw
*51228zb	2824	Pressure Regulating Thumb Screw for 66773
51229e	2818	Shuttle Driver Cushion Spring Screw for 125064 and 125086
51246a1	2818	Feed Lifting Rock Shaft Centre Set Screw
51246a1	2818	Feed Rock Shaft Centre Set Screw
51246a1	2818	Oscillating Rock Shaft Centre (left) Set Screw

No.	Plate	
51246a1	2818	Oscillating Rock Shaft Centre (right) Set Screw
51282zj	2817	Shuttle Race Slide Spring Screw for 125338
51303r	2826	Bobbin Winder Stop Latch Hinge Screw for 125327
51312zb	2823	Stitch Regulating Thumb Screw for 171520
51319r	2826	Bobbin Winder Frame Hinge Screw for 125327
51682zb	2825	Tension Regulating Thumb Nut with 45339 for 125420
55531	2114	Hand Attachment Crank Lever Lock Pin Spring for 94051
55621	2824	Presser Bar Lifter
66601	2826	Bobbin Winder Frame Spring for 125327
66670	2826	Bobbin Winder Frame for 125366
66752	2824	Pressure Regulating Thumb Screw Plug (felt) for 66773
66773	---	Pressure Regulating Thumb Screw 51228zb with 66752

No.	Plate	
80011	2824	Presser Bar Spring
80028	2114	Hand Attachment Pinion Dowel Pin for 94070
*80340	---	Arm
85893	2821	Embroidery Foot (for art work)
86649	---	Blind Stitch Attachment
86718	---	Buttonhole Attachment
86742	2574	Ruffler for 161324 and 161325
87586	---	Embroidery Hoop (round, birch) 5 $\frac{3}{8}$ " diam. × 7 $\frac{7}{16}$ " high, Nos. 101336 and 101337
87589	2659	Embroidery Hoop (round, birch) 8" diam. × 7 $\frac{7}{16}$ " high, Nos. 101338 and 101339
87593	---	Embroidery Hoop (round, birch) 10" diam. × 7 $\frac{7}{16}$ " high, Nos. 101340 and 101341
87595	---	Embroidery Hoop (round, birch) 12" diam. × $\frac{1}{2}$ " high, Nos. 101342 and 101343
87597	---	Embroidery Hoop (oval, birch) 12" × 5 $\frac{1}{2}$ " × 7 $\frac{7}{16}$ " high, Nos. 101344 and 101345

No.	Plate	
†94016	2284	Hand Attachment Gear Cover for 94052
†94027	2284	Hand Attachment Body Bracket for 94052
†94028	2114	Hand Attachment Crank Handle for 94034b
94029b	2114	Hand Attachment Crank Handle Spindle for 94034b
94031za	2284	Hand Attachment Crank Lever for 94034b
94032	2114	Hand Attachment Crank Lever Lock Pin for 94051
94033zb	2114	Hand Attachment Crank Lever Lock Pin Head for 94051
94034b	---	Hand Attachment Crank, complete, Nos. 94028, 94029b and 94031za, for 94052
94036	2114	Hand Attachment Driver Finger for 94041
94037	2114	Hand Attachment Driver Finger Latch for 94052
94038	2114	Hand Attachment Driver Finger Latch Spring for 94052
94039	2114	Hand Attachment Driver Finger Driving Pad (raw-hide) for 94041
94040	2114	Hand Attachment Driver Finger Driving Pad Plate for 94041
94041	---	Hand Attachment Driver Finger 94036, with SS567e, 94039 and 94040, for 94052
94044	2114	Hand Attachment Driver Finger Hinge Pin for 94052
†94046	2114	Hand Attachment Driver for 94070
94048	2114	Hand Attachment Pinion for 94070
†94050	2284	Hand Attachment Body for 94052
†94051	2284	Hand Attachment Gear with 5553†, 94032 and 94033zb, for 94052
†94052	2284	Hand Attachment, complete, Nos. SS565e, SS566e, SS599f, SS600f, 94016, 94027, 94034b, 94037, 94038, 94041, 94044, 94050, 94051, 94069, 94070, two each 183e and 399za
94069	2114	Hand Attachment Crank Hinge Pin for 94052
94070	---	Hand Attachment Driver 94046 with 80028 and 94048, for 94052

† As the Hand Attachment is used on Coloured Machines
of other classes it is necessary to state Colour of Machine.

No.	Plate	
96416	—	Embroidery Hoop (round, birch) 7" diam. × 7 ^m / ₁₆ " high, Nos. 101346 and 101347 ...
96417	—	Embroidery Hoop (round, birch) 5 ⁵ / ₈ " diam. × 7 ^m / ₁₆ " high, Nos. 101348 and 101349 ...
96418	2659	Embroidery Hoop (round, birch) 7" diam. × 7 ^m / ₁₆ " high, Nos. 101350 and 101351 ...
96419	—	Embroidery Hoop (round, birch) 8" diam. × 7 ^m / ₁₆ " high, Nos. 101352 and 101353 ...
96420	—	Embroidery Hoop (round, birch) 10" diam. × 7 ^m / ₁₆ " high, Nos. 101354 and 101355 ...
96421	—	Embroidery Hoop (round, birch) 12" diam. × 1/2" high, Nos. 101356 and 101357 ...
96422	2659	Embroidery Hoop (oval, birch) 9" × 4 1/2" × 7 ^m / ₁₆ " high, Nos. 101358 and 101359 ...
96423	—	Embroidery Hoop (oval, birch) 9" × 4 1/2" × 7 ^m / ₁₆ " high, Nos. 101360 and 101361 ...
96424	—	Embroidery Hoop (oval, birch) 12" × 5 1/2" × 7 ^m / ₁₆ " high, Nos. 101362 and 101363 ...
96425	2399	Embroidery Hoop Clamping Bracket for 101349, 101361 and 101363 ...
96426	2399	Embroidery Hoop Clamping Bracket for 101351, 101353, 101355, 101361 and 101363 ...
96427	2399	Embroidery Hoop Clamping Bracket Rivet for 101349, 101351, 101353, 101355, 101361 and 101363 ...
96844	2399	Embroidery Hoop Clamping Bracket for 101357 ...
96845	2399	Embroidery Hoop Clamping Bracket Rivet for 101357 ...

No.	Plate	
101246	—	Embroidery Hoop (round, birch) 10" diam. × 7 ^m / ₁₆ " high, Nos. 101364 and 101365 ...
101336	—	Embroidery Hoop (inner) for 87586 ...
101337	—	Embroidery Hoop (outer) for 87586 ...
101338	—	Embroidery Hoop (inner) for 87589 ...
101339	—	Embroidery Hoop (outer) for 87589 ...
101340	—	Embroidery Hoop (inner) for 87593 ...
101341	—	Embroidery Hoop (outer) for 87593 ...
101342	—	Embroidery Hoop (inner) for 87595 ...
101343	—	Embroidery Hoop (outer) for 87595 ...
101344	—	Embroidery Hoop (inner) for 87597 ...
101345	—	Embroidery Hoop (outer) for 87597 ...
101346	—	Embroidery Hoop (inner) for 96416 ...
101347	—	Embroidery Hoop (outer) for 96416 ...
101348	—	Embroidery Hoop (inner) for 96417 ...
101349	—	Embroidery Hoop (outer) with SS528j, NN95j, two 96425 and four 96427, for 96417 ...
101350	—	Embroidery Hoop (inner) for 96418 ...
101351	—	Embroidery Hoop (outer) with SS528j, NN95j, two 96426 and four 96427, for 96418 ...
101352	—	Embroidery Hoop (inner) for 96419 ...
101353	—	Embroidery Hoop (outer) with SS528j, NN95j, two 96426 and four 96427, for 96419 ...
101354	—	Embroidery Hoop (inner) for 96420 ...
101355	—	Embroidery Hoop (outer) with SS528j, NN95j, two 96426 and four 96427, for 96420 ...
101356	—	Embroidery Hoop (inner) for 96421 ...
101357	—	Embroidery Hoop (outer) with SS528j, NN95j, two 96844 and four 96845, for 96421 ...
101358	—	Embroidery Hoop (inner) for 96422 ...
101359	—	Embroidery Hoop (outer) for 96422 ...
101360	—	Embroidery Hoop (inner) for 96423 ...
101361	—	Embroidery Hoop (outer) with SS528j, NN95j, 96425, 96426 and four 96427 for 96423 ...
101362	—	Embroidery Hoop (inner) for 96424 ...
101363	—	Embroidery Hoop (outer) with SS528j, NN95j, 96425, 96426 and four 96427, for 96424 ...
101364	—	Embroidery Hoop (inner) for 101246 ...
101365	—	Embroidery Hoop (outer) with Spring, for 101246 ...

From the array of Information Needle Corp

No.	Plate	
120687	2821	Imitation Hemstitching Attachment with yielding presser plate
120842	2821	Hemmer (foot), $\frac{5}{8}$ " hem (packed with accessories)
120861	—	Tin of Oil (3 oz.) for 161324 and 161325
121094	2719	Darning Foot (spring) for 161325
121170	909	Ruffler Shirring Plate
121441	2574	Gathering Foot (double toe) for 161324 and 161325
121464	2574	Binder for 161324 and 161325
121547	909	Under Braider
125018	2820	Shuttle, $1\frac{1}{8}$ " diam., complete, Nos. 2515, 2518 and 15277
125021u	2822	Crank Connecting Rod with 125044 and two 896al
125044	2822	Crank Connecting Rod Oil Pad (felt) for 125021u
125047	2822	Feed Forked Connection Slide Block for 125335
125048c	2818	Feed Lifting Rock Shaft Centre (left)
125048c	2818	Feed Rock Shaft Centre (left)
125048c	2818	Oscillating Rock Shaft Centre (left)
125049c	2818	Feed Lifting Rock Shaft Centre (right)
125049c	2818	Feed Rock Shaft Centre (right)
125049c	2818	Oscillating Rock Shaft Centre (right)
125052	2824	Needle Bar Bushing
125055u	2818	Oscillating Rock Shaft with 125056
125056	2818	Oscillating Rock Shaft Oil Wick (braided cotton) for 125055u
*125057u	—	Oscillating Shaft Crank for 125058 and 125059
*125058	—	Oscillating Shaft Crank 125057u with 462al and 125330 for 125086
125059	2818	Oscillating Shaft Crank 125057u with 125330 and two 462al
*125066	—	Feed Bar Roller Stud for 1813
*125060	—	Oscillating Shaft Crank Slide Block Stud for 125330
125061	2824	Presser Bar
*125062cu	—	Shuttle Driver for 125063 and 125092
*125063	—	Oscillating Shaft 2510u with 2049 and 125062cu for 125086
125064	—	Shuttle Driver 125092 with 125065 and two 51229e (for Agents only)
125065	2818	Shuttle Driver Cushion Spring for 125064 and 125086
125068	2826	Bobbin Winder Spindle for 125366
125072	2824	Needle Bar Bushing Oil Pad (felt)

No.	Plate	
125079	2824	Needle Bar
*125086	—	Oscillating Shaft 125063 with 125058, 125065 and two 51229e
125092	2818	Shuttle Driver 125062cu with two 462al for 125664
125113	2817	Throat Plate
125258	—	Face Plate Tension Seat for 125384
125262u	2822	Feed Forked Connection with 175u, for 125340
125270	2818	Feed Rock Shaft
125314	2825	Tension Spring for 125418
125316	2825	Thread Take-up Spring for 125418
125317j	2825	Thread Take-up Spring Regulator for 125368
†125324	2826	Bobbin Winder Bracket (belt cover) for 125327
125326	2826	Bobbin Winder Tripping Arm for 125327
†125327	2826	Bobbin Winder (automatic), complete, Nos. 190r, 15287, 51303r, 51319r, 6666C1, 125324, 125326, 125366, 125376 and 125462 for Hand Wheel No. 15282 or No. 32672
125330	2818	Oscillating Shaft Crank Slide Block 15170, with 125060, for 125058 and 125059
125331	2822	Arm Oil Pad (felt) for oiling Arm Shaft Back Bearing for 171507
125333	2822	Arm Oil Pad Spring for 171507
125334	2822	Arm Oil Pad Spring Cap for 171507
125335	—	Feed Forked Connection Slide Block 125047 with 1085e, for 125340
125336	2817	Shuttle Race Slide for 125338
125337	2817	Shuttle Race Slide Spring for 125338
125338	2817	Shuttle Race Slide, complete, Nos. 125336, 125337 and two 51282zj
125340	—	Feed Forked Connection 125262u with 125335
125366	2826	Bobbin Winder Frame 66670, with 15288 and 125068 for 125327
*125367	—	Face Plate for 125384
125368	—	Face Plate 125384, with 857zb, 50292zb and 125317, for 125412
125369	2825	Face Plate Thread Guard 125428 with 125373, for 125384
125373	—	Face Plate Thread Guard Rivet for 125369
125376	2826	Bobbin Winder Stop Latch for 125327
125381	—	Feed Reversing Handle 45305 with 1550r, for 125398

† In ordering it is necessary to state Class of Machine.

From the library of: International Textile Corp.

No.	Plate	
125384	2825	Face Plate 125367, with 15410, 125258 and 125369, for 125368
125395	2826	Bobbin Winder Tension Bracket for 125396
125396	2826	Bobbin Winder Tension Bracket, complete, Nos. 45847, 45915, 45916, 125395 and 140138zb
125397	2822	Feed Regulator for 125398
125398	—	Feed Regulator 125397 with 125381
125399	2822	Feed Regulator Hinge Screw Washer
125400	2823	Stitch Regulating Thumb Screw Friction Washer for 171520
125412	—	Face Plate, complete, Nos. 125368 and 125418
125416	2825	Tension Indicator Flange for 125418
125417	2825	Tension Releasing Pin for 125418
125418	2825	Tension, complete, Nos. 45865, 125314, 125316, 125416, 125417, 125419 to 125421 and two 2102 for 125412
125419	2825	Thread Take-up Spring Thread Guard for 125418
125420	—	Tension Stud 140175zj with 51682zb for 125418
125421	2825	Tension Indicator for 125418
125425	2823	Arm Side Cover
125428	—	Face Plate Thread Guard for 125369
125462	2826	Bobbin Winder Stop Latch Spring for 125327
125481	2823	Stitch Regulating Plate for 171520

No.	Plate	
140138u	2818	Feed Throw-out Pitman Rod Washer Screw
140138zb	2826	Bobbin Winder Tension Screw for 125396
140175zj	2825	Tension Stud for 125420
140543L	—	Number Plate Drive Screw for 171507
140543L	—	Trademark Screw for 171507
140545c	2824	Needle Clamp Thumb Screw for 2054
160845	2719	Presser Foot (left toe) for Edge Stitching, Cording and Slide Fastener Work
160846	2719	Presser Foot (right toe) for Edge Stitching, Cording and Slide Fastener Work
161127	2719	Presser Foot (hinged, adjustable) for sewing on the right or left side of the needle, for Edge Stitching, Cording and Slide Fastener Work, for 161324 and 161325
161294	2574	Screw Driver (machine) for 161324 and 161325
161295	2574	Screw Driver (bobbin case) for 161324 and 161325
161307	—	Needle Threader (wire) for 161324 and 161325
161324	—	Attachment Set (packed in cardboard box), complete, Nos. 25527b, 50053b, 86742, 120861, 121441, 121464, 161127, 161294, 161295, 161307, two 8879 and six needles 15×1 (three each sizes 11 and 14), for all countries except Denmark, Norway, Sweden and Switzerland
161325	—	Attachment Set (packed in cardboard box) complete, Nos. 25527b, 50053b, 86742, 120861, 121094, 121441, 121464, 161127, 161294, 161295, 161307, two 8879 and six needles 15×1 (three each sizes 11 and 14), for Denmark, Norway, Sweden and Switzerland

No.	Plate	
171502	2822	Clamp Stop Motion Clamp Washer for 15314
171507	—	Arm and Bed, with Nos. 125331, 125333, 125334 and four 140543L
171508	2822	Arm Shaft 15497 with 15434, 15498, 171509 and 171512
171509	2822	Arm Shaft Counterbalance with 1285al for 171508
171512	2822	Feed Cam with 1285al for 171508
171515	2820	Shuttle Race Cap for 171540 to 171542
171519	2823	Stitch Indicator Plate for 171520
171520	—	Stitch Regulating Plate 125481 with 45310, 51312zb, 125400 and 171519
171539	2820	Shuttle Race Body for 171540 to 171542
171540	—	Shuttle Race Body 171539 with 171515 and two 662j (<i>for Agents only</i>)
171541	2820	Shuttle Race, complete, Nos. 171515, 171539, 171543 to 171546, 173551, two each 87k, 662j, 173536 and 173538
171542	—	Shuttle Race, complete, Nos. 2515, 171515, 171539, 171543 to 171546, 173551, two each 87k, 662j, 173536 and 173538 (<i>for Agents only</i>)
171543	2820	Shuttle Race Gate for 171541 and 171542
171544	2820	Shuttle Race Gate Hinge Stud for 171541 and 171542
171545	2820	Shuttle Race Gate Hinge Stud Nut for 171541 and 171542
171546	2820	Shuttle Race Gate Hinge Stud Spring for 171541 and 171542
171549	—	Needle Clamp Thread Guide
173508cu	2818	Feed Bar
173510u	2818	Feed Lifting Rock Shaft for 173511
173511	—	Feed Lifting Rock Shaft with Feed Throw- out Assembly, complete, Nos. 173510u, 173513 and 173520u
173512	2818	Feed Lifting Rock Shaft Crank with 704u and 50150al for 173513
173513	—	Feed Lifting Rock Shaft Crank with Feed Throw-out Lever, complete, Nos. 173512 and 173515 to 173517 for 173511
173514	2818	Feed Throw-out Knob with 442al
173515	2818	Feed Throw-out Lever with 1813 for 173513
173516	2818	Feed Throw-out Lever Tension Spring for 173513
173517u	2818	Feed Throw-out Lever Tension Spring Hinge Stud for 173513
173518u	2818	Feed Throw-out Pitman Rod

No.	Plate	
173519u	2818	Feed Throw-out Plunger
173520u	2818	Feed Throw-out Plunger Bracket for 173511
173536	2820	Shuttle Race Gate Latch for 171541 and 171542
173538	2820	Shuttle Race Gate Latch Spring for 171541 and 171542
173547	2818	Feed Throw-out Knob Shaft and Bobbin Winder Spool Pin
173551	2820	Shuttle Race Gate Hinge Pin for 171541 and 171542
*173602	—	Bed